

Memory Module Specifications

KF552C36BBEA-8

8GB 1G x 64-Bit

DDR5-5200 CL36 288-Pin DIMM



SPECIFICATIONS

CL(IDD)	40 cycles
Row Cycle Time (tRCmin)	48ns(min.)
Refresh to Active/Refresh Command Time (tRFCmin)	295ns(min.)
Row Active Time (tRASmin)	32ns(min.)
UL Rating	94 V - 0
Operating Temperature	0° C to +85° C
Storage Temperature	-55° C to +100° C

DESCRIPTION

Kingston FURY KF552C36BBEA-8 is a 1G x 64-bit (8GB) DDR5-5200 CL36 SDRAM (Synchronous DRAM) 1Rx16, memory module, based on four 1G x 16-bit FBGA components per module. The module supports AMD® EXPO v1.0 and Intel® Extreme Memory Profiles (Intel® XMP) 3.0. Each module has been tested to run at DDR5-5200 at a low latency timing of 36-40-40 at 1.25V. The SPDs are programmed to JEDEC standard latency DDR5-4800 timing of 40-39-39 at 1.1V. Each 288-pin DIMM uses gold contact fingers. The JEDEC standard electrical and mechanical specifications are as follows:

FEATURES

- Power Supply: VDD = 1.1V Typical
- VDDQ = 1.1V Typical
- VPP = 1.8V Typical
- VDDSPD = 1.8V to 2.0V
- On-Die ECC
- Height 1.66" (42.23mm), w/heatsink

FACTORY TIMING PARAMETERS

- Default (JEDEC): DDR5-4800 CL40-39-39 @1.1V
- EXPO Profile #0: DDR5-5200 CL36-40-40 @1.25V
- EXPO Profile #1: DDR5-4800 CL38-38-38 @1.1V
- XMP Profile #1: DDR5-5200 CL36-40-40 @1.25V
- XMP Profile #2: DDR5-4800 CL38-38-38 @1.1V

Continued >>

MODULE WITH HEAT SPREADER

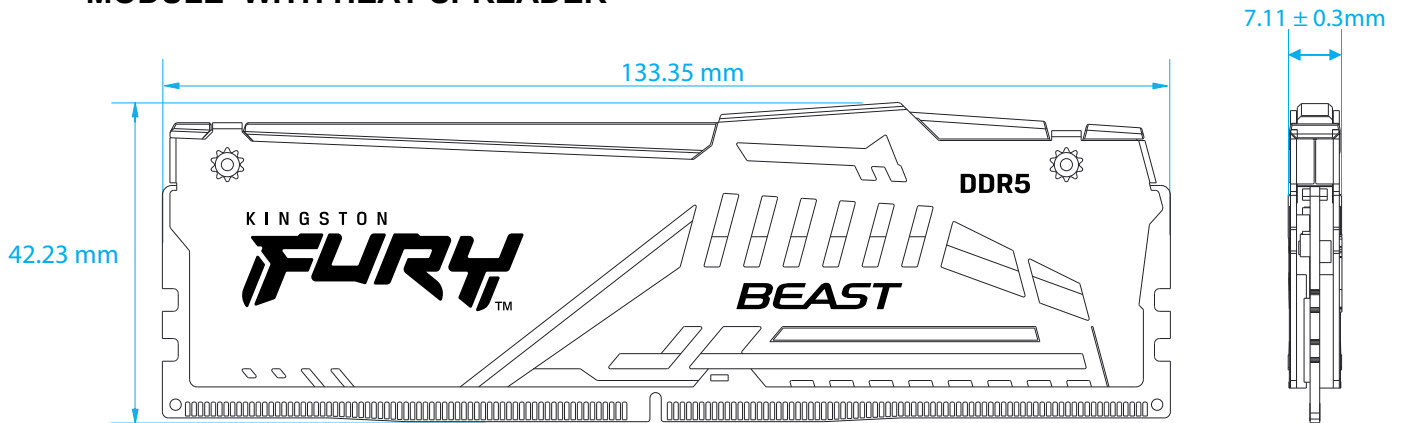

MODULE DIMENSIONS

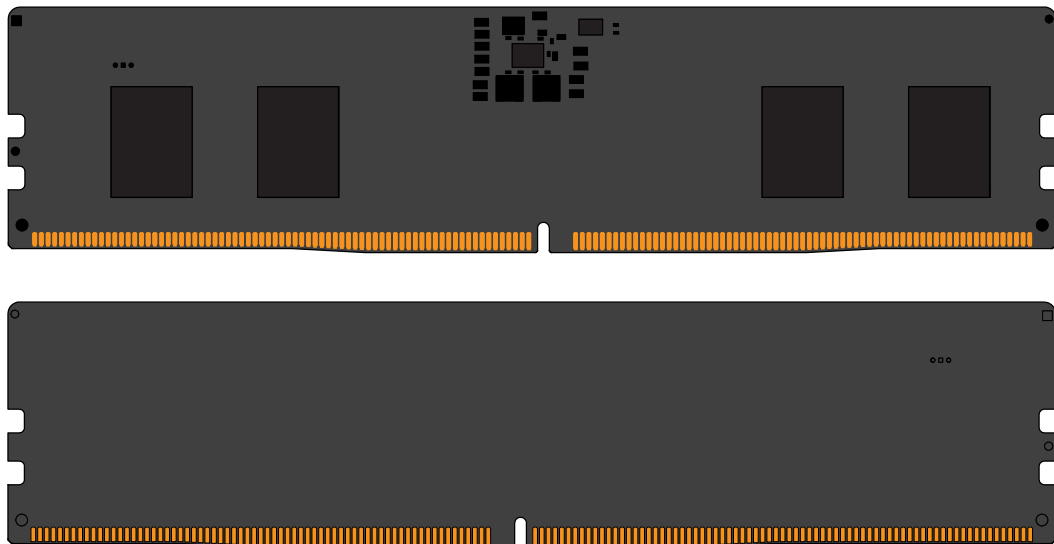

All measurements are in millimeters.
(Tolerances on all dimensions are ± 0.12 unless otherwise specified)

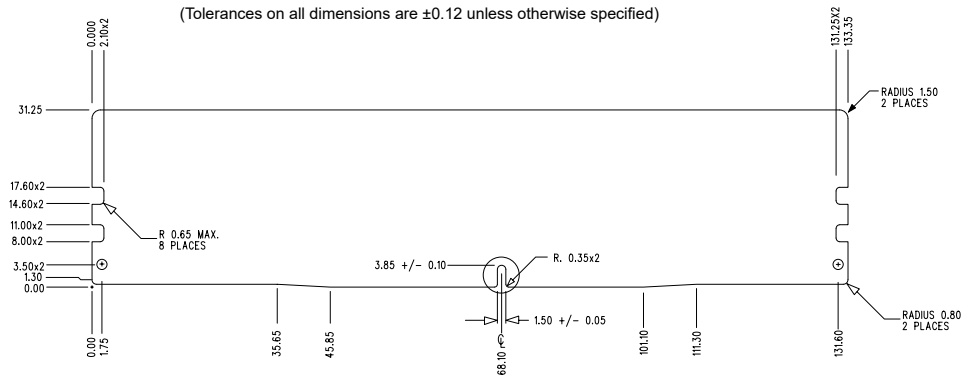

The product images shown are for illustration purposes only and may not be an exact representation of the product.
Kingston reserves the right to change any information at anytime without notice.

FOR MORE INFORMATION, GO TO KINGSTON.COM

All Kingston products are tested to meet our published specifications. Some motherboards or system configurations may not operate at the published Kingston FURY memory speeds and timing settings. Kingston does not recommend that any user attempt to run their computers faster than the published speed. Overclocking or modifying your system timing may result in damage to computer components.